

ISL6236EVAL1

Evaluation Kit - System Regulation Application

AN1271
Rev 1.00
Dec 22, 2008

This application note describes the ISL6236 evaluation board intended for applications in notebook computers and other battery-powered devices.

Description

As notebook computer and battery-powered equipment complexity increases, higher levels of power management integration are required to meet market demands. To respond to the dynamic needs of its customers, Intersil introduces the quad outputs, multi-function power supply controller ISL6236. Its two fully programmable switch-mode power supplies (SPMS), one programmable and one fixed LDO outputs provide a robust power management solution for an extremely wide range of applications. In addition, it includes an optional 14V charge pump. For more information on the detailed workings of the ISL6236, please consult the ISL6236 Data Sheet on the Intersil Company website (<http://www.intersil.com>)

What's Inside

The Evaluation Board Kit contains the following materials:

- ISL6236 EVAL1 REV A Board
- ISL6236 Data Sheet
- ISL6236 Application Note (this document)

What's Needed

The following materials will be needed to perform testing:

- +25V, 20A Power Supply
- +5.0V, 750mA Power Supply
- Electronic Load up to 15A
- Precision digital multimeter
- 4-Channel oscilloscope

Note: amperage rating of power supplies are determined by maximum expected loading plus a percentage margin of error.

Quick Setup Guide

1. Set the +25V power supply to +7V and place in the "STANDBY" or "OFF" position. Connect the positive terminal (+) of the supply to the +VIN terminal P1 and the negative terminal (-) of the supply to GND P2.
2. Connect the positive terminal (+) of the electronic load to the VOUT1 terminal P5. Connect the negative terminal (-) of the electronic load to the GND terminal P6. Make sure the electronic load is set to the 0A condition.
3. Check to ensure all switches are in their default positions prior to application of power (refer to "Detailed Description of Switch Settings" on page 2).
4. Set all power supplies to the "ON" position. Check both 5V and 25V power supply outputs with a DMM to ensure correct voltage levels. Adjust if necessary.
5. Measure the default output voltages using DMM across the test points.
 - VOUT1: P7(+) to P8(-), it should read 5.0V
 - VOUT2: P5(+) to P6(-), It should read 3.3V
 - LDO: P3(+) to P4(-), It should read 5.0V
 - VREF3: P14(+) to P8(-), It should read 3.3V
 - CHARGE PUMP: P28(+) to P8(-), it should read 14.0V.

At this point, the board has been properly powered up. Normal testing can begin.

Summary

The ISL6236EVAL1 is an adaptable evaluation tool which showcases the performance of the ISL6236 chipset designed to meet the power management requirements of personal notebook computers or portable devices.

The following pages provide jumper settings, pinout, schematic of the board, bill of materials and layout drawings to support implementation of this solution.

The Intersil's total power management portfolio continues to expand with new selections to better fit our customer's needs. Refer to our web site for updated information: <http://www.intersil.com>

For technical assistance or other assistance please call 1-888-INTERSIL (468-3774).

How to Change Output Settings

Use following tables to change the adjustable outputs.

TABLE 1.

V _{OUT1}	FUNCTION
5V	FB1 = GND, Default
1.5V	FB1 = VCC
0.7V to 5.5V	$V_{FB} \cdot (1 + R_{11}/R_{12})$ where $V_{FB} = 0.7V$

TABLE 2.

V _{OUT2}	FUNCTION
3.3V	REFIN2 = VCC, Default
1.05V	REFIN2 = VREF3
0.5V to 2.5V	VREFIN2, where $V_{REFIN2} = 0.5$ to $2.5V$

TABLE 3.

LDO	FUNCTION
5V	LDOREFIN = GND, Default
3.3V	LDOREFIN = VCC
0.7V to 4.5V	$2 \times V_{LDOREFIN}$, where $V_{LDOREFIN} = 0.35V$ to $2.25V$

Detailed Description of Switch Settings

TABLE 4.

SW1	EN2	FUNCTION
1	GND	V _{OUT2} shut down
2	VCC*	V _{OUT2} Active
3	REF	V _{OUT2} sequence to Vout1

TABLE 5.

SW2	SKIP	FUNCTION
1	GND	Normal operational mode, automatic switch over to Pulse Skipping at light load
2	VCC*	Low Noise, fixed-frequency PWM
3	REF	Normal Operation Mode with Ultrasonic Pulse-skipping, 20kHz min.

TABLE 6.

SW3	EN_LDO	FUNCTION
1	GND	LDO shut down
2	VCC*	LDO Active
3	N/C	No Connect

TABLE 7.

SW4	BYP	FUNCTION
1	GND	Set BYP to 0V, No LDO switchover
2	VOUT1*	Bypasses LDO Voltage with V _{OUT1}
3	VOUT2	Bypasses LDO Voltage with V _{OUT2}

TABLE 8.

SW5	EN1	FUNCTION
1	GND	Vout1 Shutdown
2	VCC*	Vout1 Active
3	REF	Vout1 sequence to Vout2

NOTE: * Indicates default settings.

For all switches, only toggle one position at a time and use break-before-make sequencing to avoid shorting VCC to GND.

Pinout

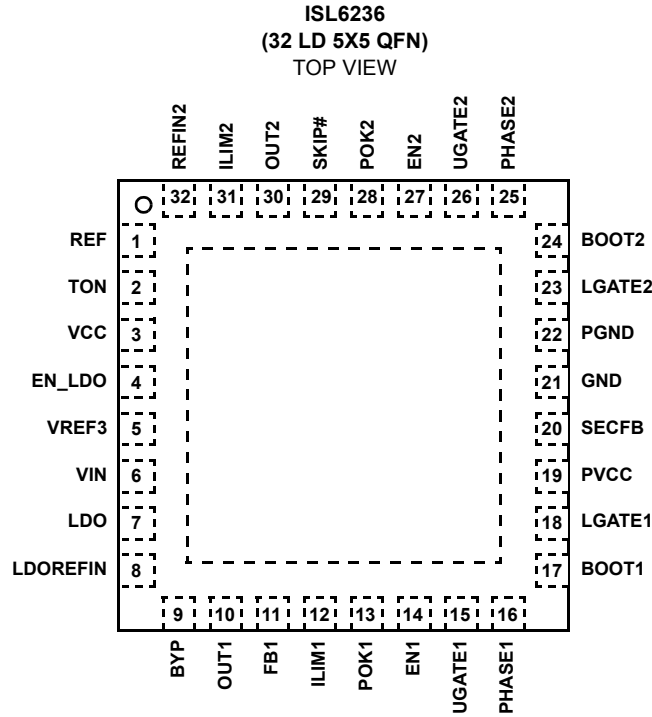

ISL6236 Evaluation Board Top and Bottom View

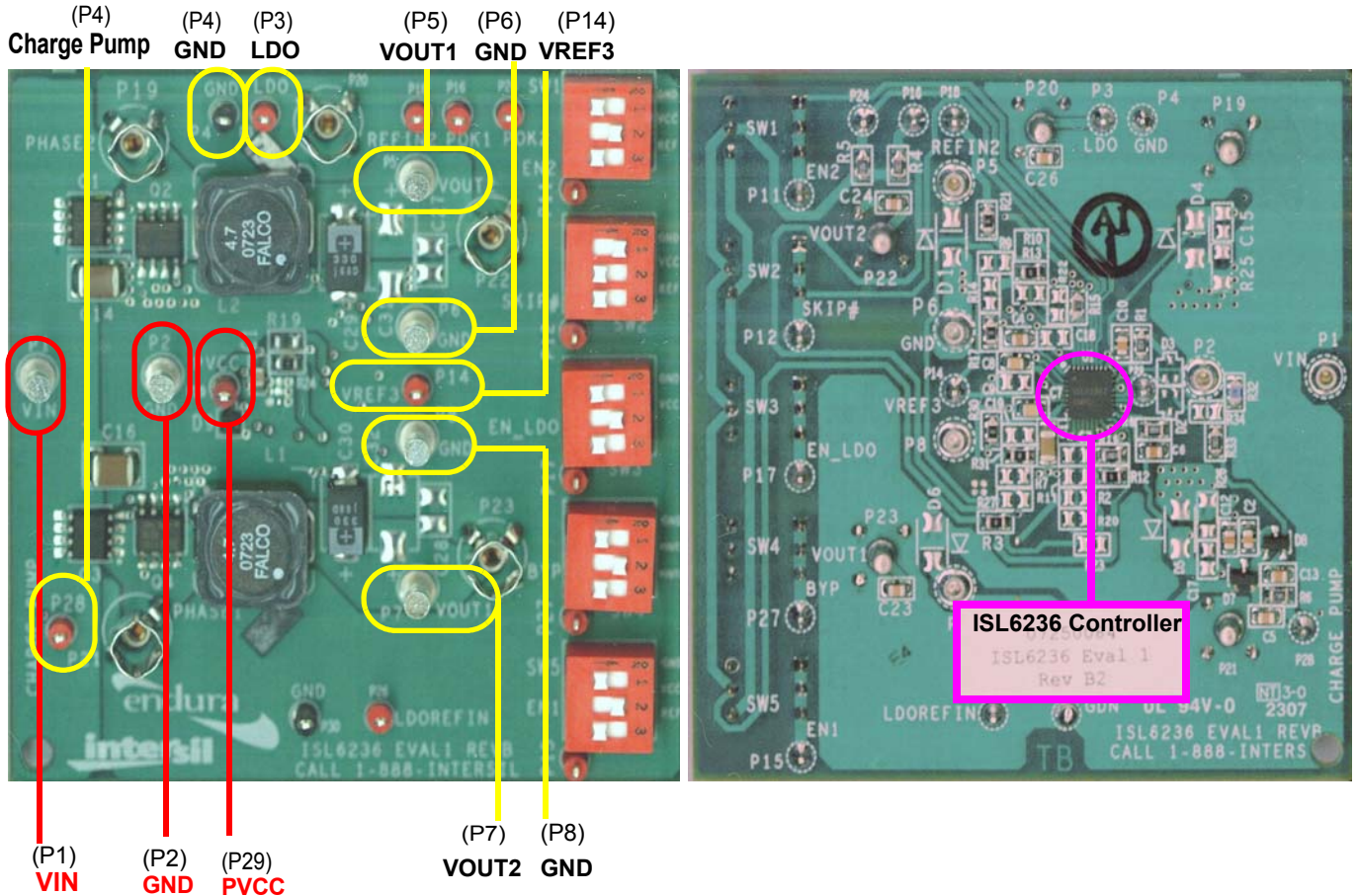

FIGURE 1. ISL6236EVAL1 REV B EVALUATION BOARD TOP AND BOTTOM VIEW

ISL6236EVAL1-Kit Schematic

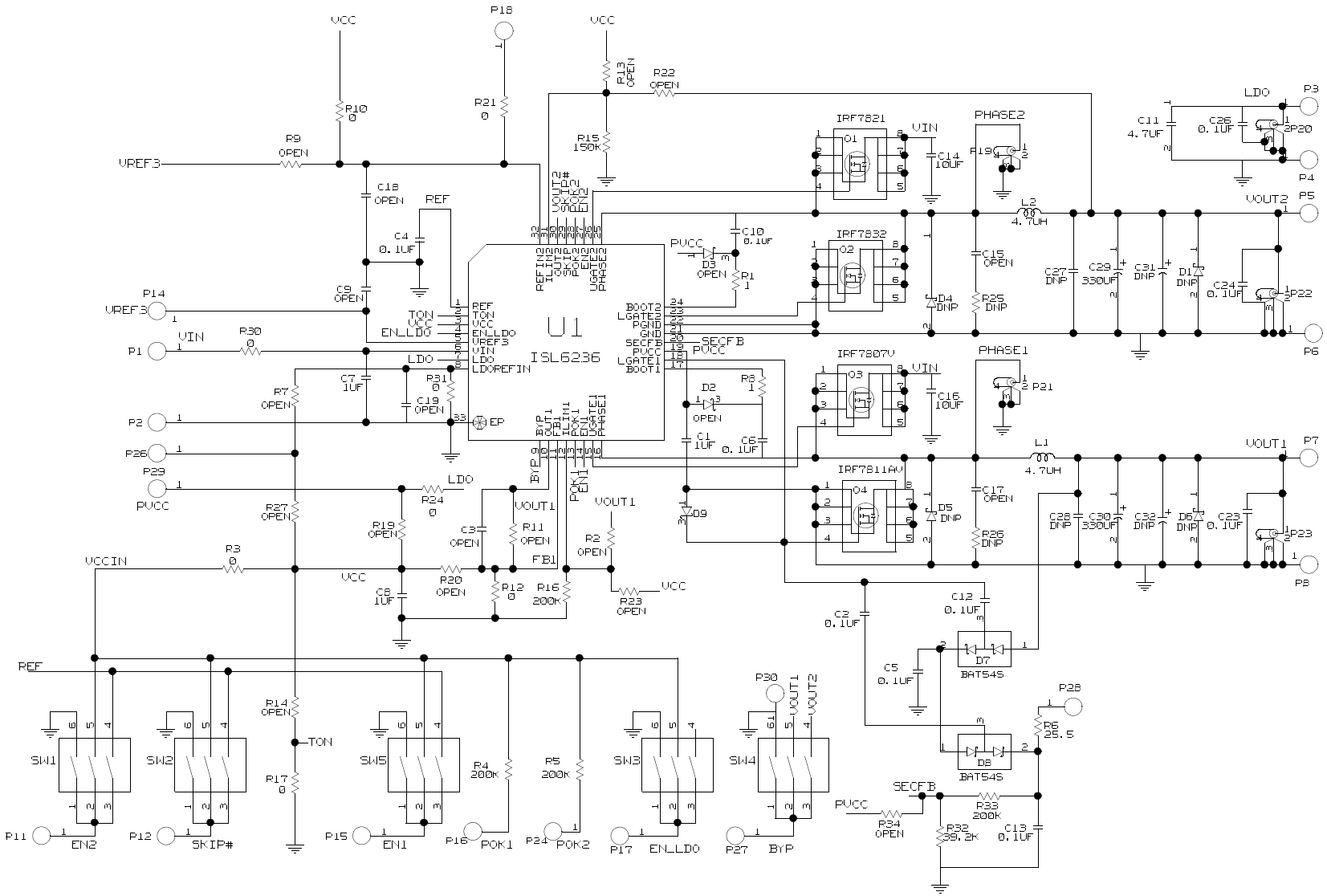

FIGURE 2. ISL6236EVAL1 REV A KIT SCHEMATIC

Components List:

REF DES	PART NUMBER	QTY	MANUFACTURER	DESCRIPTION
C1, C7, C8	08053D105KAT2A	3	AVX	1 μ F, 25V, X7R, 0805
C11	H1065-00475-10V10	1	GENERIC	4.7 μ F, 10V, X5R, 1206
C14, C16	TMK432BJ106KM	2	TAIYO-YUDEN	10 μ F, 25V, X5R, 1210
C2, C4, C5, C6, C10, C12, C13, C23, C24, C26	H1046-00104-50V10	10	GENERIC	0.1 μ F, 50V, X7R, 0805
C27, C28	OPEN	0	-	-
C29, C30	6TPD330M	2	POSCAP SANYO	330 μ F, 6.3V, POS CAP 9m Ω , D size
C3, C9, C15, C17, C18, C19	OPEN	0	-	-
C31, C32	OPEN	0	POSCAP	-
D1, D4-D6	OPEN	0	DIODES-INC	-
D2, D3	OPEN	0	ON-SEMI	-
D7, D8	BAT54sST	2	DIODES	0.2A, 30V, Schottky SOT23
D9	BAT54WT1-T	1	ON-SEMI	2A, 30V, Schottky SOT23
L1, L2	SD1003	2	FALCO	4.7 μ H, 7m Ω , 12.5x12.5mm Shielded
P1, P2, P5 to P8	1514-2	6	KEYSTONE	Test Point Turret 0.150 Pad 0.100 Thole
P19-P23	131-4353-00	5	TEKTRONIX	Scope Probe Test Point PCB Mount
P3, P11, P12, P14 to P18, P24, P26 to P29	5000	13	KEYSTONE	Miniature Red Test Point 0.100 Pad 0.040 Thole
P4, P30	5001	2	KEYSTONE	Miniature Black Test Point 0.100 Pad 0.040 Thole
Q1	IRF7821	1	IR	30V, 13.6A HEXFET Power MOSFET
Q2	IRF7832	1	IR	30V, 20A HEXFET Power MOSFET
Q3	IRF7807V	1	IR	30V, 8.3A N-Channel Power MOSFET
Q4	IRF7811AV	1	IR	30V, 10.8A N-Channel Power MOSFET
R1, R8	H2512-00010-1/8W	2	GENERIC	1 Ω , 1%, 0805
R15	H2512-01503-1/10W1	1	GENERIC	150k Ω , 1%, 0805
R2, R7, R9, R11, R13, R14, R18, R19, R20, R22, R23, R27, R34	OPEN	0	-	-
R25, R26	OPEN	0	-	-
R3, R10, R12, R17, R21, R24, R30, R31	H2512-00R00-1/10W	8	GENERIC	0 Ω , 1%, 0805
R32	H2512-03922-1/10W1	1	GENERIC	39.2k Ω , 1%, 0805
R4, R5, R16, R33	H2512-02003-1/10W1	4	GENERIC	200k Ω , 1%, 0805
R6	H2512-025R5-1/8W1	1	GENERIC	25.5 Ω , 1%, 0805
SW1 to SW5	78B03S	5	GRAYHILL	Dip Switch SPST (Raised Slide)
U1	ISL6236IRZA	1	INTERSIL	High-Efficiency, Quad Output Controller

Layout

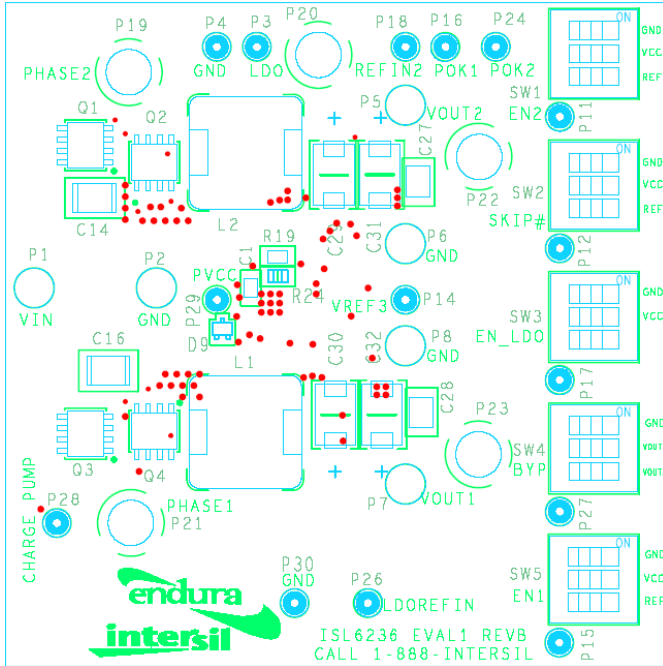

FIGURE 3. TOP COMPONENTS

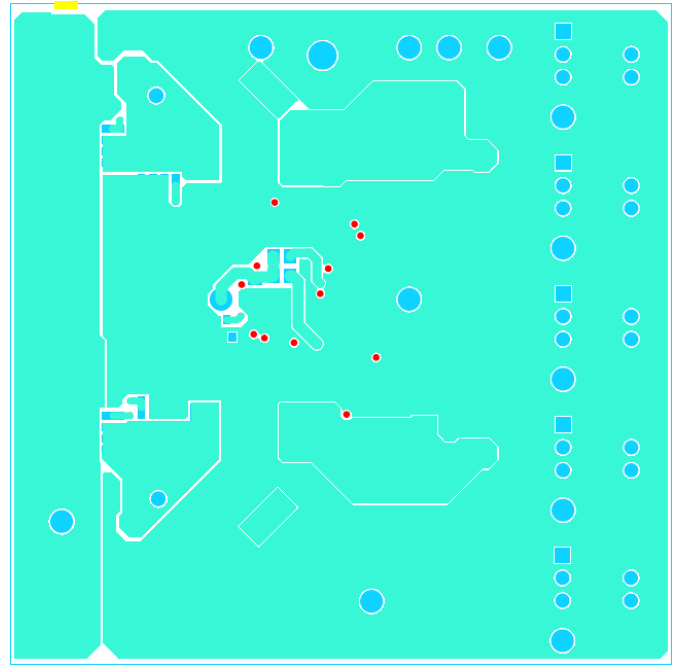

FIGURE 4. TOP ETCH

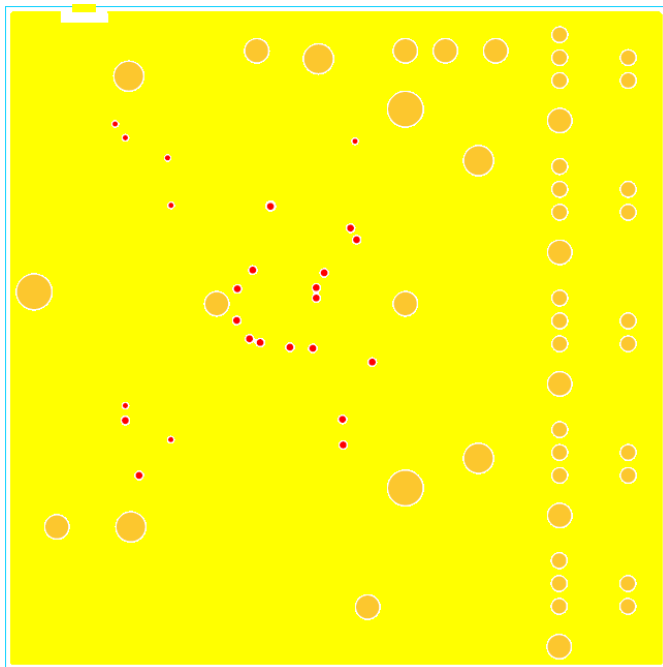

FIGURE 5. 2nd LAYER

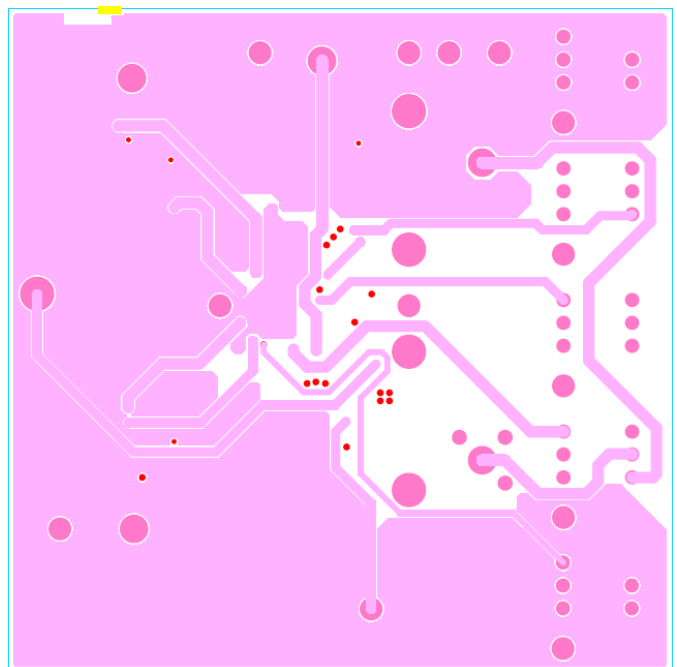

FIGURE 6. 3rd LAYER

Layout (Continued)

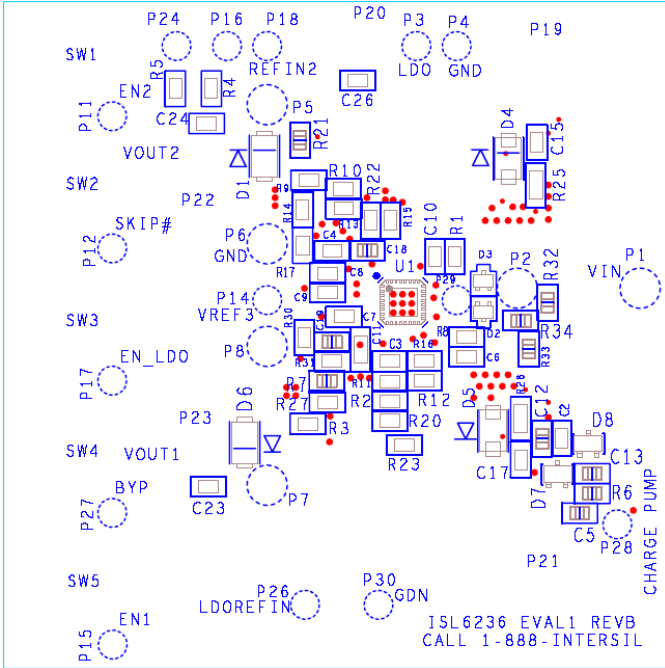

FIGURE 7. BOTTOM COMPONENTS (MIRRORED)

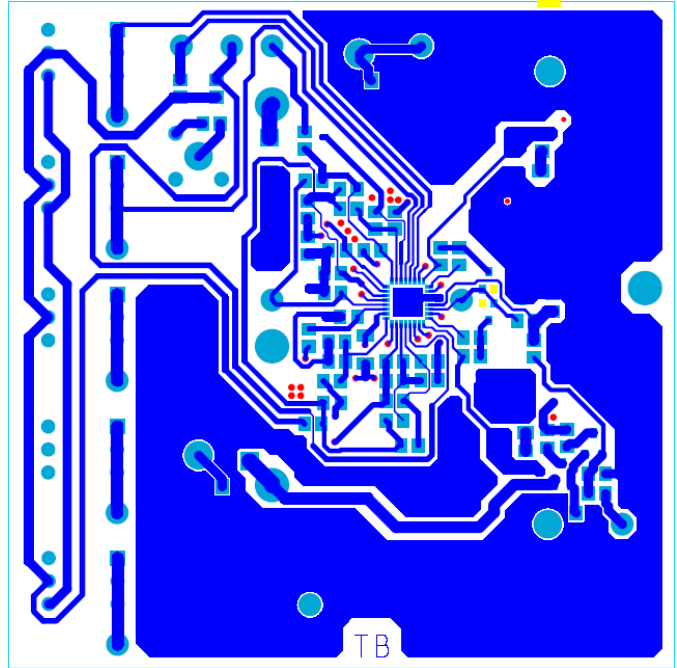

FIGURE 8. BOTTOM ETCH (MIRRORED)

Notice

1. Descriptions of circuits, software and other related information in this document are provided only to illustrate the operation of semiconductor products and application examples. You are fully responsible for the incorporation or any other use of the circuits, software, and information in the design of your product or system. Renesas Electronics disclaims any and all liability for any losses and damages incurred by you or third parties arising from the use of these circuits, software, or information.
2. Renesas Electronics hereby expressly disclaims any warranties against and liability for infringement or any other claims involving patents, copyrights, or other intellectual property rights of third parties, by or arising from the use of Renesas Electronics products or technical information described in this document, including but not limited to, the product data, drawings, charts, programs, algorithms, and application examples.
3. No license, express, implied or otherwise, is granted hereby under any patents, copyrights or other intellectual property rights of Renesas Electronics or others.
4. You shall not alter, modify, copy, or reverse engineer any Renesas Electronics product, whether in whole or in part. Renesas Electronics disclaims any and all liability for any losses or damages incurred by you or third parties arising from such alteration, modification, copying or reverse engineering.
5. Renesas Electronics products are classified according to the following two quality grades: "Standard" and "High Quality". The intended applications for each Renesas Electronics product depends on the product's quality grade, as indicated below.
"Standard": Computers; office equipment; communications equipment; test and measurement equipment; audio and visual equipment; home electronic appliances; machine tools; personal electronic equipment; industrial robots; etc.
"High Quality": Transportation equipment (automobiles, trains, ships, etc.); traffic control (traffic lights); large-scale communication equipment; key financial terminal systems; safety control equipment; etc.
Unless expressly designated as a high reliability product or a product for harsh environments in a Renesas Electronics data sheet or other Renesas Electronics document, Renesas Electronics products are not intended or authorized for use in products or systems that may pose a direct threat to human life or bodily injury (artificial life support devices or systems; surgical implantations; etc.), or may cause serious property damage (space system; undersea repeaters; nuclear power control systems; aircraft control systems; key plant systems; military equipment; etc.). Renesas Electronics disclaims any and all liability for any damages or losses incurred by you or any third parties arising from the use of any Renesas Electronics product that is inconsistent with any Renesas Electronics data sheet, user's manual or other Renesas Electronics document.
6. When using Renesas Electronics products, refer to the latest product information (data sheets, user's manuals, application notes, "General Notes for Handling and Using Semiconductor Devices" in the reliability handbook, etc.), and ensure that usage conditions are within the ranges specified by Renesas Electronics with respect to maximum ratings, operating power supply voltage range, heat dissipation characteristics, installation, etc. Renesas Electronics disclaims any and all liability for any malfunctions, failure or accident arising out of the use of Renesas Electronics products outside of such specified ranges.
7. Although Renesas Electronics endeavors to improve the quality and reliability of Renesas Electronics products, semiconductor products have specific characteristics, such as the occurrence of failure at a certain rate and malfunctions under certain use conditions. Unless designated as a high reliability product or a product for harsh environments in a Renesas Electronics data sheet or other Renesas Electronics document, Renesas Electronics products are not subject to radiation resistance design. You are responsible for implementing safety measures to guard against the possibility of bodily injury, injury or damage caused by fire, and/or danger to the public in the event of a failure or malfunction of Renesas Electronics products, such as safety design for hardware and software, including but not limited to redundancy, fire control and malfunction prevention, appropriate treatment for aging degradation or any other appropriate measures. Because the evaluation of microcomputer software alone is very difficult and impractical, you are responsible for evaluating the safety of the final products or systems manufactured by you.
8. Please contact a Renesas Electronics sales office for details as to environmental matters such as the environmental compatibility of each Renesas Electronics product. You are responsible for carefully and sufficiently investigating applicable laws and regulations that regulate the inclusion or use of controlled substances, including without limitation, the EU RoHS Directive, and using Renesas Electronics products in compliance with all these applicable laws and regulations. Renesas Electronics disclaims any and all liability for damages or losses occurring as a result of your noncompliance with applicable laws and regulations.
9. Renesas Electronics products and technologies shall not be used for or incorporated into any products or systems whose manufacture, use, or sale is prohibited under any applicable domestic or foreign laws or regulations. You shall comply with any applicable export control laws and regulations promulgated and administered by the governments of any countries asserting jurisdiction over the parties or transactions.
10. It is the responsibility of the buyer or distributor of Renesas Electronics products, or any other party who distributes, disposes of, or otherwise sells or transfers the product to a third party, to notify such third party in advance of the contents and conditions set forth in this document.
11. This document shall not be reprinted, reproduced or duplicated in any form, in whole or in part, without prior written consent of Renesas Electronics.
12. Please contact a Renesas Electronics sales office if you have any questions regarding the information contained in this document or Renesas Electronics products.
(Note 1) "Renesas Electronics" as used in this document means Renesas Electronics Corporation and also includes its directly or indirectly controlled subsidiaries.
(Note 2) "Renesas Electronics product(s)" means any product developed or manufactured by or for Renesas Electronics.

(Rev.4.0-1 November 2017)



SALES OFFICES

Renesas Electronics Corporation

<http://www.renesas.com>

Refer to "<http://www.renesas.com/>" for the latest and detailed information.

Renesas Electronics America Inc.
1001 Murphy Ranch Road, Milpitas, CA 95035, U.S.A.
Tel: +1-408-432-8888, Fax: +1-408-434-5351

Renesas Electronics Canada Limited
9251 Yonge Street, Suite 8309 Richmond Hill, Ontario Canada L4C 9T3
Tel: +1-905-237-2004

Renesas Electronics Europe Limited
Dukes Meadow, Millboard Road, Bourne End, Buckinghamshire, SL8 5FH, U.K
Tel: +44-1628-651-700, Fax: +44-1628-651-804

Renesas Electronics Europe GmbH
Arcadiastrasse 10, 40472 Düsseldorf, Germany
Tel: +49-211-6503-0, Fax: +49-211-6503-1327

Renesas Electronics (China) Co., Ltd.
Room 1709 Quantum Plaza, No.27 ZhichunLu, Haidian District, Beijing, 100191 P. R. China
Tel: +86-10-8235-1155, Fax: +86-10-8235-7679

Renesas Electronics (Shanghai) Co., Ltd.
Unit 301, Tower A, Central Towers, 555 Langao Road, Putuo District, Shanghai, 200333 P. R. China
Tel: +86-21-2226-0888, Fax: +86-21-2226-0999

Renesas Electronics Hong Kong Limited
Unit 1601-1611, 16/F., Tower 2, Grand Century Place, 193 Prince Edward Road West, Mongkok, Kowloon, Hong Kong
Tel: +852-2265-6688, Fax: +852-2886-9022

Renesas Electronics Taiwan Co., Ltd.
13F, No. 363, Fu Shing North Road, Taipei 10543, Taiwan
Tel: +886-2-8175-9600, Fax: +886-2-8175-9670

Renesas Electronics Singapore Pte. Ltd.
80 Bendemeer Road, Unit #06-02 Hyflux Innovation Centre, Singapore 339949
Tel: +65-6213-0200, Fax: +65-6213-0300

Renesas Electronics Malaysia Sdn.Bhd.
Unit 1207, Block B, Menara Amcorp, Amcorp Trade Centre, No. 18, Jln Persiaran Barat, 46050 Petaling Jaya, Selangor Darul Ehsan, Malaysia
Tel: +60-3-7955-9390, Fax: +60-3-7955-9510

Renesas Electronics India Pvt. Ltd.
No.777C, 100 Feet Road, HAL 2nd Stage, Indiranagar, Bangalore 560 038, India
Tel: +91-80-67208700, Fax: +91-80-67208777

Renesas Electronics Korea Co., Ltd.
17F, KAMCO Yangjae Tower, 262, Gangnam-daero, Gangnam-gu, Seoul, 06265 Korea
Tel: +82-2-558-3737, Fax: +82-2-558-5338